

## zelsius® C5-IUF

### Installation and operating manual

*Electronic compact heat meter  
with ultrasonic flow sensor IUF  
optionally M-Bus, wM-Bus and 3 inputs/outputs  
optional qp 0,6/1,5/2,5 m<sup>3</sup>/h*



## Installation manual

### General information

With zelsius C5 IUF, you have acquired one of the most up-to-date, modern heat meters currently available on the market. By this version, the water volume is determined based on the transit time method. The measurement accuracy is based on the measurement requirements of EN 1434 class 2, optionally class 3. Expressive symbols in the display and easy menu navigation make readout simple. Can be operated with one single button. It is equipped with a long-life battery made for operation during the initial verification validity period (5 years) including a reserve of at least another year. The meter can be equipped optionally with a battery lifetime of 11 years.

### MID - Initial verification

zelsius® C5-IUF is produced and tested in compliance with the new European Measuring Instruments Directive (MID). According to this directive, devices are no longer carrying an initial verification stamp, but rather the year of the device's declaration of conformity (recognizable on the front of the device, for example: M12). The MID controls the use of heat meters up to the moment they are placed on the market resp. their first putting into use. After this, the national regulations for devices subject to compulsory verification apply within the EU. The duration of initial verification validity in Germany remains 5 years for heat meters.

After this period has expired the measuring device may no longer be used for billing in commercial use. The regulations resp. validity period may vary in other countries of the EU. ZENNER International GmbH & Co. KG declares that this product with the number of the EC type-examination certificate DE-12-MI004-PTB010 complies with the requirements of the EC directives 2004/22/EC (Measuring instruments directive) and 89/336/EEC (electro-magnetic compatibility)

### Electro-magnetic interference

zelsius® C5-IUF fulfils the national and international requirements for interference resistance. To avoid malfunctions due to other interferences, do not install fluorescent lamps, switch cabinets or electric devices such as motors or pumps in the immediate vicinity of the meter. Cables leaving the meter should not be laid parallel to live cables (230V) (minimum distance 0.2m/)

### Care instructions

Clean plastic surfaces with a damp cloth only. Do not use any scouring or aggressive cleaning agents!

The device is maintenance-free during the service life. Repairs can only be made by the manufacturer. The most up-to-date information about this product and of our installation notice can be found at [www.zenner.com](http://www.zenner.com).

Technical data flow sensor IUF								
Nominal flow $q_p$	$m^3/h$	0,6	1,5	2,5				
Maximum flow $q_s$	$m^3/h$	1,2	3	5				
Minimum flow $q_i$	l / h	6 / 12 / 24	15 / 30 / 60	25 / 50 / 100				
Pressure loss at $q_p$	bar	$\leq 0,25$ bar						
Medium temperature range	$^{\circ}C$	$0^{\circ}C \leq \Theta \leq 90^{\circ}C / 0^{\circ}C \leq \Theta \leq 130^{\circ}C$						
Minimum pressure (to avoid cavitation)	bar	1 bar at $q_p$ and $80^{\circ}C$ medium temperature range						
Measurement accuracy class		3 / 2						
Nominal pressure/peak pressure	PS/PN	Body with threaded connection		16/16				
	PS/PN	Body with flange/DN		16/16 / 25/25				
IP-Protection class		68						
Installation position		in any position						
Installation		return flow optionally forward flow						
Cable length up to calculator	m	1,2						
Installation place temperature sensorsd		M10 x 1						
Heat carrier (Medium)		Water						
Nominal diameter	DN	15	15	20				
Connecting threads*	Nominal flow $q_p$ ( $m^3/h$ )	L [mm]	Threaded connection	Flange / ND				
					0,6	110	G3/4B	--
					0,6	130	G1B	--
					0,6	190	G1B	20
					1,5	110	G3/4B	--
					1,5	130	G1B	--
					1,5	190	G1B	20
					2,5	130	G1B	--
					2,5	190	G1B	20

\* optionally

<b>Technical data calculator</b>		
Temperature range	°C	0...105 / 0...150 *
Temperature difference range	K	3...80 / 3...130 *
Display		LCD 8-stellig + Sonderzeichen
Ambient temperature during operation	°C	5...55
Storage temperature	°C	-20...+65
Resolution temperature	°C	0,01
Measurement frequency	s	adjustable ex works, beginning with 2s, standard 30s
Unit to read the heat consumption		Standard MWh; optionally kWh, GJ
Data storage		1 x daily
Due date values		Storage of all monthly values during the entire operation time
Maximum value storage		extensive storage of flow rate, performance and other parameters
Interface	Standard	Optical interface (ZVEI, IrDA)
	optional	M-Bus, wM-Bus, RS485, radio
Supply		3,6 V lithium battery (different capacities)
Battery lifetime	Years	> 6, opt. > 11 (changeable during the operation time)
Protection class		IP54
EMC		A
Ambient conditions/climatic influencing (valid for complete compact meter)	- climatic	Highest permissible ambient temperature 55°C, Lowest permissible ambient temperature 5°C, Humidity class IP54
	- mechanical class	M1
	- electro-magnetic class	E1

<b>Technical data temperature sensors</b>		
Platinum precision resistor		Pt 1000
Sensor diameter type	mm	45 x 5,0 mm / 45 x 5,2 mm / DS 27,5 more on request
Temperature range	°C	0 – 105/0...150
Cable length	m	1,5 (opt. 5)
Installation	VL	by direct immersion or by immersion sleeves (in case of existing measuring points)
	RL	by direct immersion or by immersion sleeves (in case of existing measuring points) Integrated in the flow sensor, optionally external

Dimensioning limits may apply for non-symmetrical temperature sensors installation.

\* optionally

## Pulse inputs and outputs (optional)

By meters with pulse outputs, the pulse value can be called up in the display (see the display overview, Level 4). The pulse value of the outputs is permanently set and corresponds with the last position of the associated display value.

### Example:

Output 1 = energy output

Energy display = XXXXX.XXX

Last position = 0.001 MWh = 1 kWh

Output pulse = 1 kWh

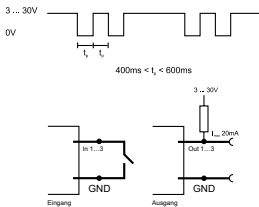

colour	connection	signification
white	I/O 1	In-/Output 1
yellow	I/O 2	In-/Output 2
green	I/O 3	In-/Output 3
brown	GND	common ground for I/O 1-3

Technical data M-Bus	
Cable length	1,5 m
Cable	D=3,8 mm, 2-core

### Technical data I/O

Load max.	max. 30V DC/20 mA
I/O 1, 2, 3	Open Drain, n-channel FET
Cable	D = 3,8 mm, 4-core
Pulse-duty factor	1:1 (out); 1:5 (in)
Cable length	1,5 m
Input frequency	max. 1 Hz

A firmly attached cable is included: external wiring must be done by oneself.

## M-Bus (optional)

The optional M-Bus interface complies with the norm 1434-3 and operates with 2400 baud fixed. The two conductors can be connected in any order to the M-Bus network.

colour	connection	signification
brown	M-Bus 1	M-Bus-Line 1
white	M-Bus 2	M-Bus-Line 2

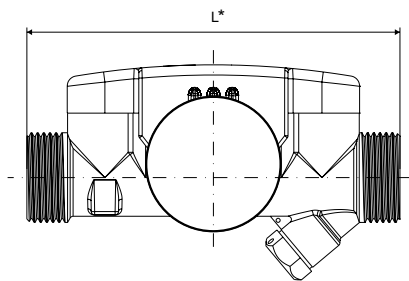

\* see page 3

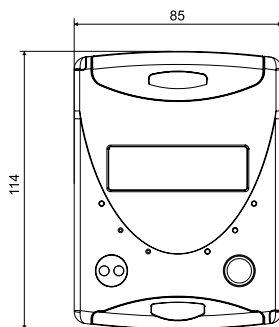
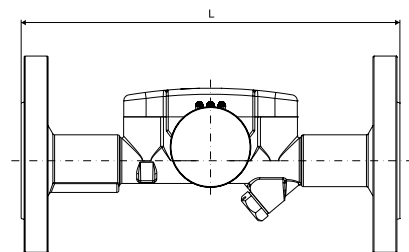
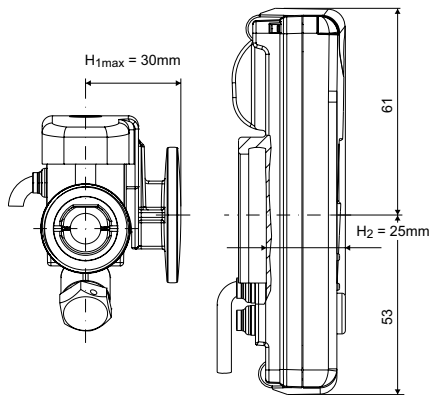

## ZENNER International GmbH & Co. KG

Römerstadt 6

D-66121 Saarbrücken

Telephone +49 681 99 676-30

Telefax +49 681 99 676-3100

E-Mail [info@zenner.com](mailto:info@zenner.com)

Internet [www.zenner.com](http://www.zenner.com)

## Installation instructions

### General Information

Read these instructions carefully right up to the end before starting to mount the device! The installation has to be done by qualified professional personnel. The current laws and regulations so as the generally accepted engineering principles have to be observed during mounting and fitting, especially EN1434 part 1+6, (in Germany also AGFW directive FW202, FW510, FW218 and DIN4713 part 4 and the initial verification directive). At devices with M-Bus the general rules of technology and the respective regulations for electrical installations have to be followed. Make sure no heating water escapes during installation – **this can cause burns!**

The maximum heating water temperature at the flow sensor may not exceed depending on version 90°C respectively 130°C. For heating water temperature over 90°C or using as a cooling meter, the detachable calculator has to be mounted separately with the supplied mounting adapter.

For heating systems with a lack of temperature mixing resp. with temperature stratification a straight pipeline of min. 10xDN has to be provided upstream of the installation point.

The flow measuring section is wear-free because no moving parts. No inlet or outlet sections are necessary. It is important to ensure adequate

system pressure to avoid cavitation. The review of the approval can be identified definitely in the display menu (Level 3).

ZENNER recommends to use direct temperature measurement and not to use immersion sleeves.

### Mounting flow sensor (VMT)

- Mount ball valves up- and downstream of the VMT.
- Consider the correct installation point (supply or return). Normally this is the return pipe (cooler pipe at heating systems). Please note the type plate information.
- Consider the correct flow direction. This is indicated by an arrow on the side of the VMT.
- The flow sensor can be installed in any position (also „overhead“).
- Do not install at highest point of piping to avoid air inside the flow sensor.
- Consider the dimensions of the heat meter.

### Notes to installation of the ball valves

- Mount ball valves up- and downstream of the meter.
- Mount a ball valve with bore M10x1 for direct sensors in the supply. This is required for the installation of the supply sensor.
- For symmetrical temperature sensor installation, mount an identical ball valve in the return. This one is used for mounting the return sensor.

### Mounting heating-/cooling energy meter

- Flush the system thoroughly before installing the heating-/cooling energy meter.
- Close valves and release pressure.
- Dismount the existing flow sensor or meter blank.
- Use only new and flawless sealing material and check the seal face for damage.
- Install the new flow sensor according to the correct flow direction and installation position.
- Turn heat computer to desired reading position.

### Mounting temperatur sensors

- The installation of the temperature sensors should be preferably symmetrical and direct installation.
- Do not remove the return sensor if already mounted on the VMU. This is also valid for all the safety seals which are mounted on the device as a standard.
- Sensors are colour-coded (red=supply, blue=return).
- The connecting cables may not be buckled, extended or shortened.
- The seal at the sensor installation point on the measuring capsule may not be damaged.
- Remove locking screw and seal at the ball valve completely, if existing.
- Attach the O-ring to the installation aid (the 2nd O-ring is only a spare O-ring). Using the installation aid, insert the O-ring into the instal-

lation point according to DIN EN 1434 with a slight circular motion.

- Using the other end of the installation aid bring the O-ring into the correct position.
- Insert the 2 halves of the plastic connector into the sensor's three notches (crimps) and press them together.
- Use the installation aid as positioning aid.
- Insert the temperature sensor into the installation point and screw it in tightly until the dead stop of the seal on the 12-point is reached (mounting torque 3-5 Nm).
- The temperature sensor installation point which is optionally integrated in the flow sensor must be secured.
- Secure the sensor after installation against unauthorised removal with appropriate sealing (available as a sealing set)!

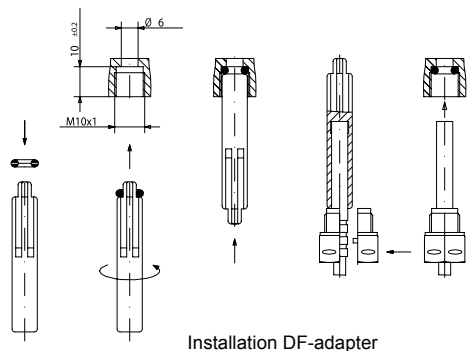



## Putting into use

- Open valves carefully and check installation for leakage.
- If the sleep mode of the counter is enabled (Display: SLEEP 1), then it must be deactivated by longer pressing the button (>5s).
- While the system is operating, check whether the volume display advances and the temperatures displayed correspond with the actual temperatures (see the display overview).
- Wait for the temperature display to be updated (1-2 sec).
- Secure meter with the enclosed sealing material against unauthorised removal.
- Fill in the putting into use report in accordance with PTB-Directive TR K9.

## Mounting in existing immersion sleeves:

The device C5 can be put into use in connection with existing immersion sleeves in accordance with the article „Putting into use of MID homologated temperature sensors” released in the PTB notifications 119 (2009), vol. 6.

Based on current information, the regulation has a period of validity until 30.10.2016. For the identification and marking of the usable existing immersion sleeves in connection with the C5 device, an identification and marking set can be delivered from our company.

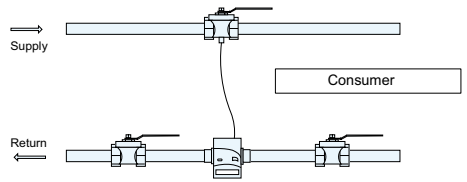



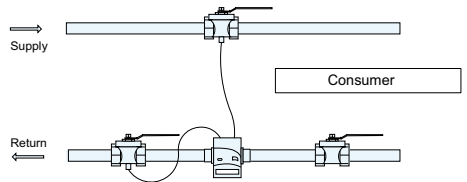

Symmetrical sensor installation for zelsius® C5-IUF with the return sensor integrated in the measuring capsule



Symmetrical sensor installation for zelsius® C5-IUF

## Status display / Error codes

The symbols in the table below show the meter's operational status. The status messages only appear in the main display (energy)! The temporary display of the warning triangle can be caused by special operating states and does not always mean that the device is malfunctioning. However, should the symbol be displayed over a longer period of time, you should contact the service company.

Symbol	Status	Event
	External voltage	-
	Flow existent	-
	Attention!	Check system/device for error
	Symbol flashing: Data transmission	-
	Symbol constantly displayed: optical interface active	-
	Emergency operation.	Exchange device

Error codes show faults detected by zelsius® C5-IUF. If more than one error appears, the sum of the error codes is displayed: Error 1005 = error 1000 and error 5.

Code	Error	Event
1	Temperature out of measuring range	Check temperature
2	Temperature out of measuring range	Check temperature
3	Short-circuit return sensor	Check temperature
4	Interruption return sensor	Check temperature
5	Short-circuit supply sensor	Check temperature
6	Interruption supply sensor	Check temperature
7	Battery voltage	Exchange device
8	Hardware error	Exchange device
9	Hardware error	Exchange device
10	Error in the measuring system	Exchange device
20	No water in the measuring tube	Check operating pressure
30	Reverse water flow detected	Check installation position
40	Air inside the medium	Vent system
50	Measured value outside overload range	Check dimensioning
100	Hardware error	Exchange device
800	Wireless interface	Exchange device
1000	Status end of the battery	Exchange device resp. battery
2000	Status initial verification expired	Exchange device

## Level 1

Heat energy  
(Main display)

468375 MWh

Cooling energy

88888888 MWh

Segment test

dd 01.12

Date last due date

Energy

Last due date

4154365 MWh

Due date cooling energy

Volume

2376429 m<sup>3</sup>

Flow rate

1370 %

Supply temperature

87.20 °C

Return temperature

35.48 °C

Temperature difference

51.72 °C

Current output

283 kW

## Level 2

Heat energy difference from last due date to now

8207 MWh

Cooling energy difference from last due date to now

14888 MWh

Heat energy difference from 1. this month to now

4036 MWh

Cooling energy difference from 1. this month to now

6048 MWh

Volume difference from 1. this month to now

0000 m<sup>3</sup>

Maximal Flow

34.18 %

Date month maximal flow

12.38 %

Maximum power, Average value since commissioning

5862 kW

Maximum heat energy power month

25003 kW

Maximum cooling energy power, average value since commissioning

5862 kW

Maximum cooling energy power month

25003 kW

## Important Note:

The optical interface has to be activated by means of the OptoHead through keypress before reading out of the device.

Devices, which are in sleep mode (Display: **SLEEP 1**) have to be activated through keypress until the energy display shows up.

Depending on you meter's model its displays can differ in number and order from those shown here.

### Level 3

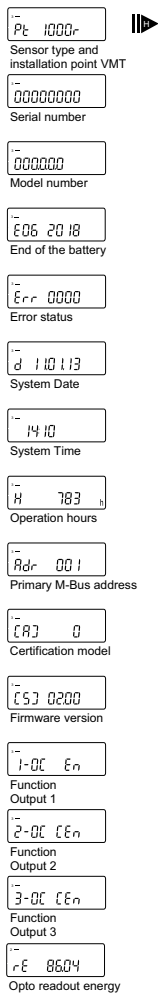

Level 3 menu items:

- Pe 1000r  
Sensor type and installation point VMT
- 00000000  
Serial number
- 000000  
Model number
- E06 20 18  
End of the battery
- Err 0000  
Error status
- d 10 13  
System Date
- 14 10  
System Time
- H 783 h  
Operation hours
- Rdr 001  
Primary M-Bus address
- CR3 0  
Certification model
- CS3 0200  
Firmware version
- 1-0C En  
Function Output 1
- 2-0C CEn  
Function Output 2
- 3-0C CEn  
Function Output 3
- rE 8604  
Opto readout energy

### Level 4

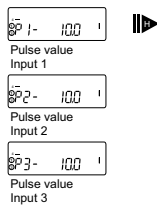



Level 4 menu items:

- SP1- 100 |  
Pulse value Input 1
- SP2- 100 |  
Pulse value Input 2
- SP3- 100 |  
Pulse value Input 3

### Legend

 Press the button briefly (S) to switch through the display from top to bottom. When you have reached the last menu item the device automatically jumps back to the menu item at the top (loop).

 Press the button for about 2 seconds (L), wait for the door symbol to appear (upper right corner of the display) and then release the button. The menu is then updated resp. switches to the sub-menu.

 Hold down the button (H) until the device switches to another level or switches back from the sub-menu.

A detailed display overview including submenus is available upon request.