

- 5.** Take off the topcover before inserting the mirror.
(Schroef de afdekkapjes van de staanders af, voordat de spiegel geplaatst wordt.)

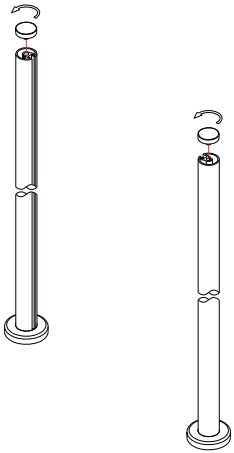

- 6.** Cut the wooden stripes to the desired length, insert the wooden stripe into the post to prevent the mirror from sliding down.
(Zaag de houtstrips op de gewenste lengte en plaats ze in de staander, zodat de spiegel niet naar beneden kan zakken.)

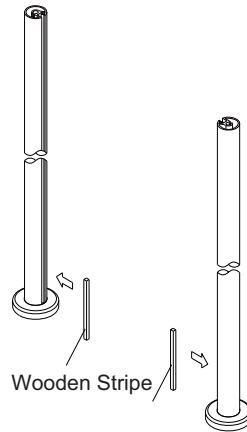

- ★ For installation points 7 and 8 two persons are necessary.
(Voor de installatiepunten 7 en 8 zijn twee personen noodzakelijk.)

- 7.** Remove one of the posts and then place mirror smoothly with care sideways in the remaining post. Use liquid soap to make the mirror go smoothly.
(Neem 1 van de staanders weg. Plaats de spiegel daarna voorzichtig zijdelings in het profiel. Gebruik vloeibare zeep om de spiegel soepel te kunnen laten glijden.)

- 8.** Place second post sideways of the mirror. Install the woodscrews in the baseplate.
(Plaats de 2^e staander ook zijdelings over de spiegel. Monteer hierna de schroeven.)

- 9.** Install the top cover.
(Monteer de afdekkappen.)

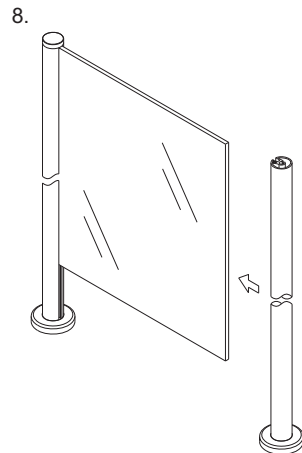
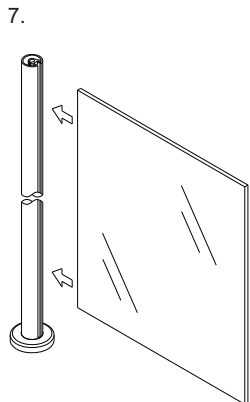
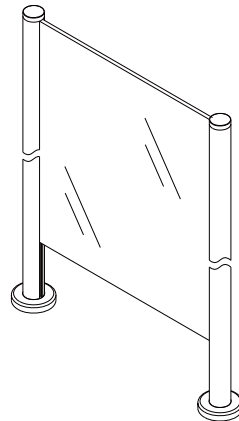

ART.NR: 80.0173 Mirror Rail

CHROME PLATED MIRRORHOLDER, HEIGHT 1000 MM,
FOR DOUBLE SIDED MIRRORS 6 MM THICKNESS, MAXIMUM WIDTH 650 MM.

VERCHROOMDE SPIEGELOPSTAND 1000 MM HOOGTE,
VOOR DUBBELZIJDIGE SPIEGELS 6 MM DIK, MAXIMAAL 650 MM BREED.

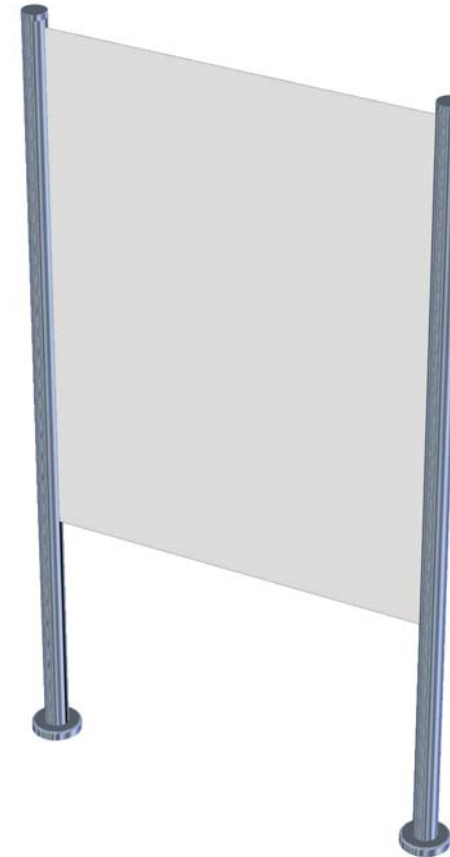

SILKLINE

- RAMINEX INTERNATIONAL B.V. • POSTBUS 40310 • 3504 AC UTRECHT • NEDERLAND
- TEL: +31 (0)30-241 1224 • FAX: +31 (0)30 241 1121
- E-MAIL: INFO@RAMINEX.NL • WEBSITE: WWW.RAMINEX.NL

Components Componenten

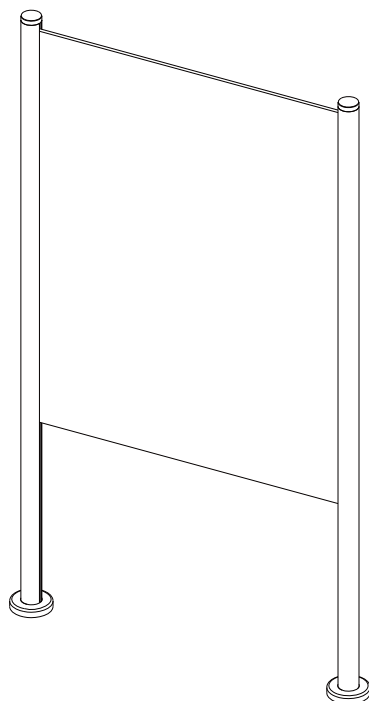

Top Cover
Afdekkap

Bottom Decorative Cover
Rozet
x2
63mmD x 12mmH x 2mmT



Plastic Plug
Plastic Plug
Ø 6 x 30 mmL
x8



Wood Screw
Houtschroef
Ø 8 x 50 mmL
x8



Round Fixing Plate
Montageplaat
x2
57mmD x 8mmH

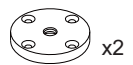

Stainless Steel Screw
Rvs Schroef
M8 x 16 mmL
x2



Wooden Stripe
Houtstrip
x2



965mmL
Aluminium Staander
Aluminium Side Post
x2



Installation Installatie

Please check if goods are in good condition before installing.
(Controleer voor installatie alle onderdelen op eventuele beschadiging en compleetheid.)

1. Use the stainless steel screw to fix the round fixing plate with the tube.
(Schroef de montageplaat aan de staander vast.)



2. The post must be installed on a flat and horizontal surface with the woodscrews/plastic plugs.
(Monteer de staander/montageplaat met de meegeleverde schroeven/pluggen op een vlakke en horizontale ondergrond.)

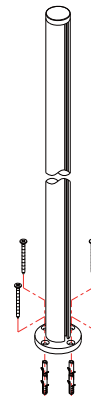

3. Insert the decorative cover all the way down to the bottom of the post.
(Plaats de rozet op de montageplaat.)



4. Install the other side post using the same procedure as above, adjust the two posts according to the actual mirror width. The center to center distance between the two posts is 13 mm extra to the mirror width.
For example if the mirror width is 60 cm, the center to center distance is 61,3 cm.
Check after installing that the posts are at a right angle.
(Installeer de tweede staander volgens dezelfde procedure. Bepaal de afstand aan de hand van de breedte van de te plaatsen spiegel. De hart op hart afstand tussen de twee staanders is de breedte van de spiegel plus 13 mm. Voorbeeld: bij een spiegel van 60 cm breedte is de hart op hart maat 61,3 cm. Controleer na montage staanders of deze loodrecht gemonteerd zijn.)

