

## Electronic pulse counter

# IZM 972



## Performance specification

ZENNER GmbH & Co. KGaA  
Römerstadt 4  
D - 66121 Saarbrücken  
Tel.: + 49 (0) 681 / 9 96 76-0  
Fax: +49 (0) 681 / 6 43 94  
email: [info@zenner.de](mailto:info@zenner.de)  
<http://www.zenner.de>

## List of contents

<b>1. INTRODUCTION .....</b>	<b>3</b>
<b>2. TECHNICAL DATA - OVERVIEW .....</b>	<b>4</b>
<b>3. PERFORMANCE SPECIFICATION .....</b>	<b>5</b>
3.1 VOLUME CALCULATION .....	5
3.1.1 <i>Slow-speed meters</i> .....	6
3.1.2 <i>High-speed meters</i> .....	6
3.2 FLOW RATE CALCULATION .....	7
3.3 THE LCD DISPLAY .....	8
3.3.1 <i>Free programmable display sequence</i> .....	9
3.3.2 <i>The main menu</i> .....	11
3.3.3 <i>The critical date menu</i> .....	13
3.3.4 <i>The configuration menu</i> .....	14
3.3.5 <i>The test menu</i> .....	16
3.4 THE STATE DISPLAYS OF THE PULSE COUNTER .....	17
3.5 THE MEMORY OF THE PULSE COUNTER (EEPROM) .....	18
3.6 ADDITIONAL MEMORY MODULES .....	19
3.7 PULSE INPUT OF MAIN METER .....	20
3.8 FURTHER PULSE INPUTS .....	20
3.9 FURTHER PULSE OUTPUTS .....	21
3.9.1 <i>Presentation of the outputs</i> .....	21
3.9.2 <i>Timing of the outputs</i> .....	22
3.9.3 <i>Basic circuit diagram</i> .....	24
3.9.4 <i>Galvanic division of the outputs</i> .....	24
3.10 LINK TO THE OUTSIDE WORLD - THE INTERFACES .....	25
3.10.1 <i>The infra-red interface</i> .....	26
3.10.2 <i>The RS232 interface</i> .....	27
3.10.3 <i>The ZR-bus interface</i> .....	27
3.10.4 <i>The M-bus interface</i> .....	27
3.11 POWER SUPPLY WITH BATTERY .....	28
3.12 EXTERNAL POWER SUPPLY .....	28
3.13 DIAGNOSIS OF THE INPUTS .....	29
<b>4. CONNECTION POSSIBILITIES .....</b>	<b>30</b>
<b>5. DIMENSIONS AND DIMENSIONAL DIAGRAMS .....</b>	<b>33</b>

# 1. Introduction

**I Z M 972** is a latest-generation microprocessor-controlled pulse counter. The pulse counter is built using the most modern SMD technology. A 75X-family NEC microprocessor ensures that the pulse counter keeps working perfectly for over 6 years. **I Z M 972** can, of course, work together with all sizes of volumetric measuring units. It is designed for wall mounting.

A non-volatile memory backs up all determinative data at regular intervals so that it cannot be lost. All devices also have an optical interface for mobile data acquisition as well as programming the most essential parameters.

In combination with our read-out systems, an internal loop memory (data logger) allows access to further data which is not retrievable on the display, e.g. the previous month's values.

The pulse counter is provided with 3 inputs. High frequency electronic meters as well as standard meters with reed sensors can be connected to the first pulse input. All kind of conventional meters with reed pulse output – for example most of the commercial water, gas and electricity- meters can be connected to both additional inputs.

The additional connections however have a multi-function, i.e. they can be programmed not only as inputs but also as remote meter outputs.

Due to its integrated clock with calendar, critical date data is also no problem for the **I Z M 972**. The I Z M 972 is able to save up to 70 previous month's values in its internal datalogger which can be read or transferred remotely via the critical date menu.

Further designs are available as an optional extra for all imaginable measuring tasks. Thus a large number of devices can, for example, be provided and read via the Bus. Here, it is just as possible to take a reading on site as it is to transfer remotely by telephone network directly to a PC. For more straightforward applications, a standard RS232 version can also be supplied which, however, enables only one device to be read respectively.

The pulse counter is already prepared for transferring data via radio networks too.

Irrespective of the design, with **I Z M 972** you have at your disposal a perfected top-grade product which fulfils almost your every wish.

## 2. Technical data - Overview

Installation site	wall mounting
Pulse input	maximum 1 Hz or 100 Hz optional
Units	meter, watt hour or without unit
Pulse valence	0.0001 .. 99999 L/Imp. or Imp./L
Power supply	Lithium battery AA ,
Battery life	>= 6 years
Supply voltage	min: 2.7 VDC max. 4.0 VDC
Current consumption	typically 8.5 up to 10 $\mu$ A
Display	LCD , 8 positions plus special characters
Data backup	EEPROM
Ambient temperature	5..50 °C in operation -15.. 60°C in storage
Additional inputs/outputs	2 pulse inputs with up to 1Hz or can be combined optionally as outputs (1Hz, 50VDC/50mA)
Interfaces	optic as standard M-bus, RS232, ZR-bus optional

## 3. Performance specification

### 3.1 Volume calculation

In each measuring cycle which is currently programmed to 60 seconds, a calculation is performed. This occurs however only if pulses have also arrived since the last cycle.

When parameters are set in the factory or at the testing site, a pulse valency is programmed into each IZM pulse counter, e.g. 10 l/Imp. This must be in accordance with the volumetric measuring unit which later supplies the volume pulses,. Only in this way can it be guaranteed that the energy is also calculated correctly. Otherwise, this can under certain circumstances be too large or even too small by a factor of 10 or 100.

In the case of conventional volumetric measuring units with a reed contact, the volume is calculated by multiplying the incoming pulses by the programmed pulse value:

$$\text{volume [l]} = \text{number of pulses [ Imp ]} * \text{pulse valency [ l/Imp ]}$$

In the case of high-speed meters, usually newer electronic meters, the volume is calculated by dividing the number of pulses by the pulse valency, since the pulse valency is given or programmed here as a reciprocal value (Imp/l).

The values for the pulse valency may in both cases lie between 0.0001 and 99999.

The calculation of the volume can occur always in l/pulse as well as in pulse/l. Both are always possible! Example: 100l/pulse= 0,01 pulse/l

In the case of standard meters, however, certain ranges of values have won through, usually representing decimal multiples of 1 and 2.5, e.g.:

1 ; 2.5 ; 10 ; 25 ; 100 ; 250 ; 1000 l/Imp

$$\text{volume [l]} = \text{number of pulses [ Imp ]} * \frac{1}{\text{pulse valency [ Imp/l ]}}$$

### 3.1.1 Slow-speed meters

By slow-speed meters we usually mean purely mechanical meters with a reed contact. For this, a pointer or a pointer disc with one or more magnets is fitted to the counter which rotate past a stationary reed contact, thereby starting off a calculating process. The pulse valencies which can be realised usually lie within the range already mentioned of between 1l and 2.5l as well as decimal multiples of this. The pulse frequency achieved in this way is relatively low and usually lies below 1 Hz.

Slow-speed volumetric measuring units should comply with the following conditions:

Minimum frequency 0.001 Hz

Maximum frequency 1 Hz

Mark-space ratio 1 : 1 ... 1 : 5

The above conditions apply correspondingly to the two additional counter inputs. Only slow-speed meters may ever be connected to these.

### 3.1.2 High-speed meters

High-speed meters usually measure the revolutions of the turbine directly or of the meter roller. Most also have additional segments or pallets, so that the pulse rates delivered correspond to twice or four times the speed of the turbine.

The frequencies generated by such meters are correspondingly high and can be anything up to 100 Hz. Due to the higher frequency, it is possible for the pulse counter to make a more exact and certain flow rate calculation, as is the case with the slow-speed meters.

High-speed meters may only be connected to the input 1. With the IZM 972, it is possible to power such meters by fitting a battery onto the connection board as an option.

The following conditions exist for the high-speed meters:

Minimum frequency 0.001 Hz

Maximum frequency 100 Hz

Mark-space ratio 1 : 1 for 100 Hz

### **3.2 Flow rate calculation**

Calculating operations, such as the calculation of the flow rate, require a lot of time, and thus use up a relatively large amount of battery capacity. In normal operation, therefore, only an approximate calculation is performed which is perfectly adequate for a fundamental consideration of the values described. If, for example, one reaches the representation of the flow rate when switching through the menu, the first calculation displayed is only about 7% accurate.

From this time on, however, an additional function is called up which continues to allow the flow rate to be calculated more accurately until the change of day at 0.00 a.m.. This means that after the flow rate measurement has been called up once via the INFO key, the calculating operations are performed more frequently and with greater accuracy. Assuming a constant flow rate over a longer period, an accuracy of 0.5 % is achieved, which can be accepted as being completely sufficient.

Should the flow rate change within a short time by more than 12 %, the assumed accuracies will again move in the magnitude of 7%, as greater calculating accuracy cannot be achieved with highly fluctuating flow rates. After the flow rate has changed, the accuracy of calculations again increases to the 0.5% mark.

After the change of day mentioned above, the additional function automatically switches off and is not activated again until the flow rate menu is called up via the display or key.

### 3.3 The LCD display

The display is a liquid crystal display with 8 positions for displaying the consumption values and many special characters for the units and state indicators.

This information can be retrieved using the INFO key. In its normal state, the meter is located in the so-called main menu and displays the quantity of the medium that should be measured or the volume. If an error has been detected by the counter, the main display is replaced by the display of the detected errors. This is important for the user as only in this way can he recognise immediately that an error is present. By pressing the INFO key once, the counter switches back to the main display.

Different pieces of consumption and information data can be brought to the display. Due to their greater clarity, these have been compiled in four different groups. A group is designated as a display level or a menu.

To get from one level to the next, hold down the INFO key for several seconds.

One can switch through the functions within one level by pressing the INFO key for a short time. If the end of a level has been reached, press it again to return to the start of the display sequence. If a menu option which is being viewed is not switched through, the display automatically jumps back to level 1 of the main display after approximately 30 seconds have expired.

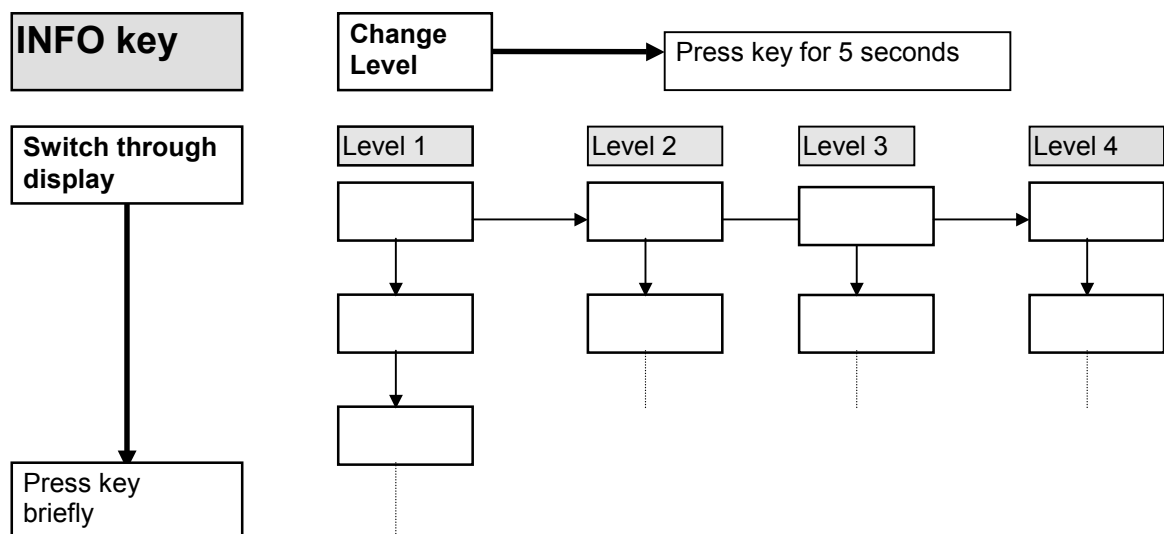





### 3.3.1 Free programmable display sequences

The following tables show all sequences that could be displayed on the liquid crystal display. On demand this menus can be individually arranged ex factory and displayed.

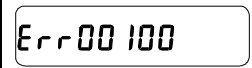
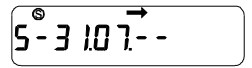
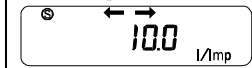
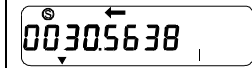
Example 1 : standard configuration, both additional meters programmed as inputs

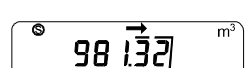
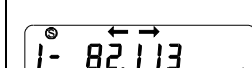
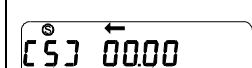
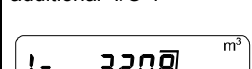
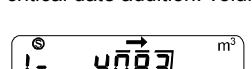
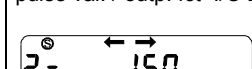
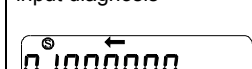
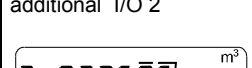
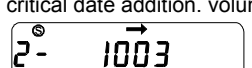
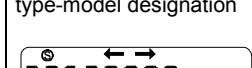
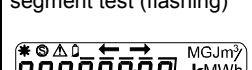
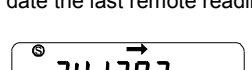
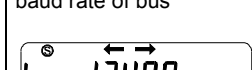
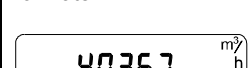
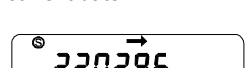
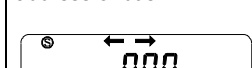
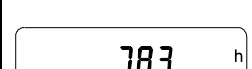
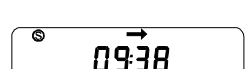
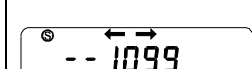
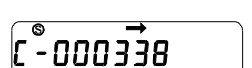
Main menu	Critical date menu →	Configuration menu ← →	Test menu ←
error display (only if available) 	critical date data 	pulse valency, volumetric measuring unit 	small volume resolution 
volume 	critical date volume 	pulse val. / outp. fct I/O 1 	software version 
additional I/O 1 	critical date addition. volume 1 	pulse val. / outp. fct I/O 2 	input diagnosis 
additional I/O 2 	critical date addition. volume 2 	type-model designation 	
segment test (flashing) 	date the last remote reading 	baud rate of bus 	
flow rate 	current date 	address of bus 	
operating hours 	current time 	life expectancy of battery 	
	customer number 		

Example 2 : additional meter 1 programmed to input, additional meter 2 to output







**Main menu**

**Critical date menu**

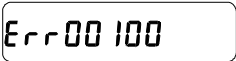
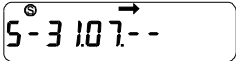
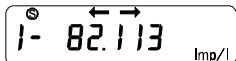
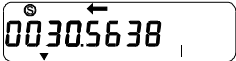
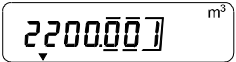
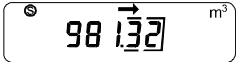
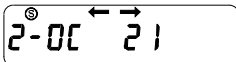
**Configuration menu**

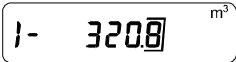
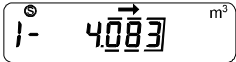
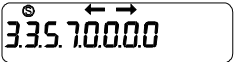
**Test menu**

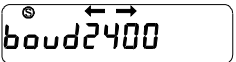
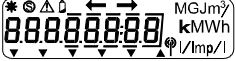
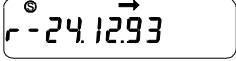
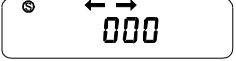
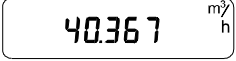
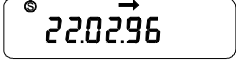
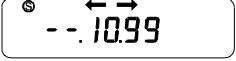

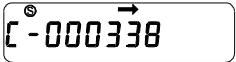
error display (only if avail.) 	critical date data 	pulse val. / output fct I/O 1 	small volume resolution 
Volume 	critical date volume 	pulse val. / output fct I/O 2 	software version 
additional I/O 1 	critical date addition. volume 1 	type-model designation 	input diagnosis 
additional I/O 2 not applicable, as programmed to output	critical date addition. volume 2 not applicable, as programmed to output	baud rate of bus 	
segment test (flashing) 	date the last remote reading 	address of bus 	
flow rate 	current date 	life expectancy of battery 	
operating hours 	current time 		
	customer number 		

### 3.3.2 The main menu

#### Error display

A rectangular LCD display showing the text "Err 0100" in a digital font.

If operating errors are detected by the IZM, these are analysed and displayed. This occurs via a multi-character error code, where all currently active error or error codes are added and simultaneously displayed. The error display becomes the main display at that moment and is displayed constantly so that the existence of an error can also be registered directly.

If no error has been detected in the system, this display is not available, i.e. this cannot be activated also by pressing the INFO key.

The complete error description and the associated codes are described in detail further below.

#### Volume

Two rectangular LCD displays side-by-side. The left display shows "2200000" with a small "m³" symbol to its right and a small downward arrow under the first zero. The right display shows "345678" with a small downward arrow under the first digit.

This value displays the accumulated consumptions. The units, along with the post-decimal positions, are selected so that they do not overflow within a billing period.

#### Volume, additional meter 1

 A rectangular LCD display showing "1- 3208" with a small "m³" symbol to its right.
 

Display in square metres, litres or unit-less

The counter features two additional counter inputs for any meters with reed pulse outputs contact water meters as standard. The volume of each additional meter is recorded and can be called up on the LC display. The meter which is connected to the input unit IO1 is represented on the LCD, as shown above, by a "1" and a hyphen. This is followed by the consumption which is recorded in m<sup>3</sup> or in litres (l) depending on programming. It is additionally possible to also display the counter reading without units. This would, for instance, be practical if other events are to be counted.

## Volume, additional meter 2

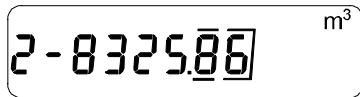

For additional meter 2, the same applies as already described under additional meter 1.

## Segment test

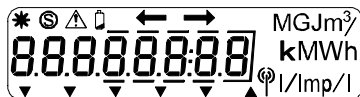

Display of all available segments

If individual segments of the LCD fail or remain on, a value could have been greatly falsified and therefore incorrectly read. For this reason, the counter offers this segment test. In the test, all available segments are switched on and off again so that the display flashes. It can now be checked whether the LCD is still functioning without errors.

## Flow rate

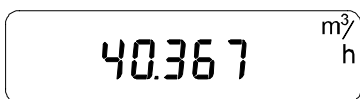

In its normal state, the flow rate calculation is not completely processed for energy-saving reasons. Thus only a result with an error of a few per cent is available. If you are located in the flow rate display though, the calculation is processed completely and after approximately 50 seconds a result is available with an error less than or equal to 1%.

## Operating hours

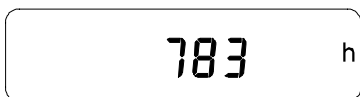

The operating hours begin to be counted when the calculating unit leaves the idle state it is in on delivery. This state is overridden by first pressing the INFO key.

### 3.3.3 The critical date menu

The critical date menu can be recognised by the arrow on the right.

#### Critical date

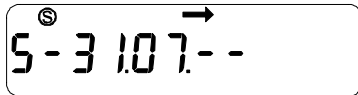

The critical date is the point in time at which the consumption of the first mounted meter and the consumptions of both additional meters are saved so that they can be retrieved at a later time. This enables billing always at the same time of year, and the reading time can be later. The date is programmed as standard to 01.08. This means that the data is stored in the transition from 31.07. to 01.08. at 0.00 a.m..

The critical date can also be programmed at the customer's request to any other day. It is also possible to carry out this change in the system on site using special software.

#### Volumes of the main meter and the additional meters 1 and 2 on the critical date

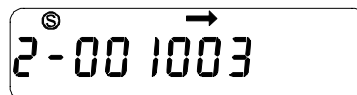
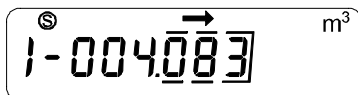
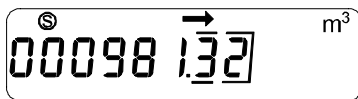

Additional meter 1 display in m<sup>3</sup>, meter 2 works without units

#### Date of last remote reading

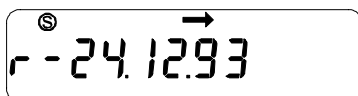

In the case of a remote reading (bus, modem, optical reading head etc.), the current date and the consumption at the time of the reading is stored. This allows the landlord to check the consumption on the day of the last remote reading when preparing invoices.

### Current date and time

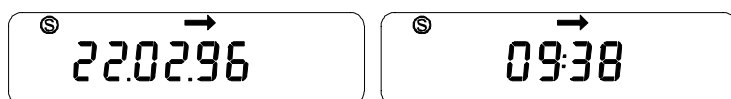

It is not possible to switch from a summer to a winter setting. The date and time can also be programmed or corrected on site as required.

### Customer-specific number

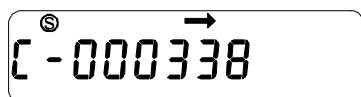

Each customer has his own number available with a maximum of 6 positions. It is stored permanently in the EEPROM. This number can be recognised by the preceding "C-". The allocation can be programmed at the factory or by means of appropriate software on site. The number is set to "0" as standard.

### 3.3.4 Configuration menu

The configuration menu can be recognised by both arrows on the right and left.

#### Pulse valency main meter

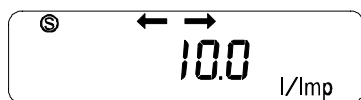

This displays the pulse valency for the volumetric measuring unit, for which the calculating unit is programmed. It is essential that this matches the volumetric measuring unit, as otherwise fatal errors can arise in the energy calculation. For this reason, the value is likewise identified on the type plate. What is decisive however, as has already been mentioned several times, is only the programmed value. This should always be checked in case of doubt. With conventional volumetric measuring units, the pulse valency displayed is given in "l/Imp". For high-speed volumetric measuring units, "Imp/l" are displayed. The display itself has 8 positions and up to a maximum of 7 post-decimal positions can be entered.

#### Pulse valency, additional meters 1 + 2



For the pulse valencies the additional meters 1 and 2 apply the same conditions as for recording the volume normally. The input is however limited to 6 positions. In addition, only a display in "L/Imp" is possible.

### Type number

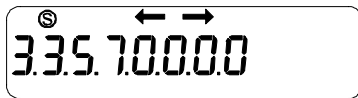

Various equipment features of the IZM as well as software parameters are encoded in the type number which allow the type which was supplied to be identified. This is however only possible for skilled technicians.

### Baud rate, bus

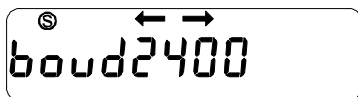

The baud rate is an important interface parameter for all devices which want to communicate with the pulse counter via the bus. It must match for both partners. Further parameters are specified as follows:

8 data bits, 1 stop bit, parity even

### Short address, bus

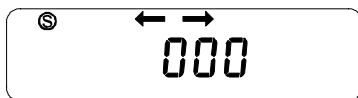

With this address the calculating unit can be addressed directly and used to send the read-out data. The valid addresses are limited from 1 to 250 in a bus network. The 0 means a new device which still has not received a bus address. The addresses can be individually assigned using configuration software, whereby the same address cannot be assigned in the same bus.

### Date "battery empty"

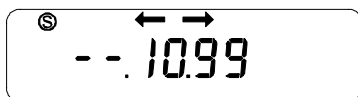

This date corresponds to the point in time when the battery is probably so empty that operation could be impaired. This only applies, however, if the measuring instrument is used in absolutely continuous operation. Should the incoming volume pulses occur less frequently than the off-period of the temperature measurement, the discharging of the battery is less and lasts beyond this date.

### 3.3.5 The test menu

The test menu can be recognised by the arrow on the left.

#### Volume, high-resolution

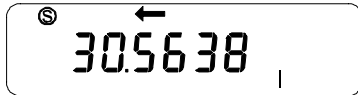

This display is a high-resolution test display for the volume with which relatively fast statements can also be made on site using the measuring system. The display window is simply shifted to the right in order to display the positions which normally cannot be seen. What happens then, however, is that if the counter reading is correspondingly large, the top positions of the display can under certain circumstances no longer be seen.

#### Software version

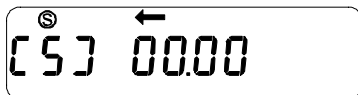

The present software version of the IZM is shown here. It serves to identify older devices. This allows the manufacturer to provide a faster service in the case of certain errors in the calculating unit.

#### Input diagnosis

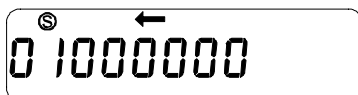

This test display can be used to visually represent different input states of the measuring system without any other resources.



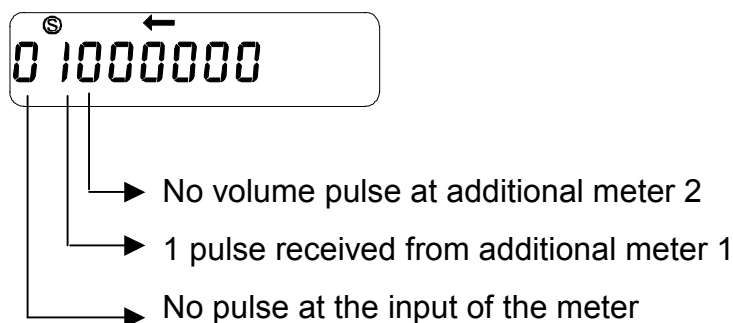





#### Example:





### 3.4 The state displays of the IZM pulse counter

The state the IZM is currently in is made known by three segments in the display. The individual displays have the following meaning:

	→	These three segments are used for the state display.
	→	No display. The meter is in normal state. Currently only volume is counted and any pulses are output.
	→	This display appears only briefly if particular functions are carried out, such as flow rate calculation, etc.
	→	The optical interface is scanned. If this display is visible, a connection set-up can be started via the optical interface.
	→	The optical interface is in receive mode. A connection set-up was detected. data can be transferred to the pulse counter.
	→	Data is sent via the optical interface from the calculating unit to the reading device.
	→	The bus supply is active. Queries can be processed by the bus.
	→	The calculating unit responds to queries from the bus.
	→	Test mode is active.

Apart from the actual state display, the asterisk indicates in each state whether pulses are currently being received. If a pulse is detected at one of the three possible pulse inputs, the asterisk is activated for approximately 0.5 seconds. It can also not be recognised when a pulse occurs, how long the pulse lasts or from which input the pulses have been received.

	→	Pulses were received.
---	---	-----------------------

### 3.5 The memory of the pulse counter (EEPROM)

The pulse counter IZM 972 requires a non-volatile memory, an EEPROM, to back up of all set parameters, to temporarily store the most important data during operation and to save the daily back up unit (every day at 23 o'clock) which allows to identify the day and the time of a possible failure of the pulse counter.

It also contains the internal data logger which enables about 70 monthly values to be stored and read at any given time. These values are updated every month, so that the last consumption data to the first of the month are always in the memory. The reading itself can only happen via the interfaces by means of PC or hand-held computers.

The non-volatile memory has the following fundamental structure :

Parameter	e.g. critical date, date, battery service life, serial number , model designation, pulse valencies, etc.
Loop memory configuration	time interval, date and time last backup, data info
Day back-up block	data saved at 23 o'clock
Critical date data block	all data saved on the critical date
Error monitoring	date and time of the first errors, error hours etc.

### 3.6 Additional memory modules

The standard version of the IZM 972 is equipped with a data logger of approximately 250 bytes. With this memory, the volume (8-position per month), for example, can be stored for about 70 months. This memory is often not sufficient and therefore the calculating unit can also operate external memory. This additional memory card is a possibility for saving the consumption information. A maximum of up to 4 different values are stored at intervals of one minute for up to 1 year, whereby the duration of storage, until the loop memory starts again from the beginning, still only depends on the size of memory. To make effective use of the memory, the storage width of a value which is to be stored can also be selected between 2, 4, 6 and 8 positions, for the smaller the storage intervals which are selected, the fewer positions have to be stored.

After being plugged in, each memory card must be adapted to the configuration of the calculating units. To activate the memory card, quit menu level 4 by pressing the INFO key for approximately 5 seconds. A small triangle pointing downwards in the display then becomes active if the memory is detected as correct. If the loop memory is incorrectly configured, the error message "Err10000" appears or, if there are hardware problems, the error "Err20000".

#### Possible data (max. 4 may be selected):

- Volume
- Additional meter 1
- Additional meter 2
- Flow rate
- Error

#### Possible storage intervals:

- every 10, 15, 30 minutes
- every hour
- every day 00:00 a.m.
- every year
- every week to the Monday
- every Monday to the 1st
- every quarter
- every year

currently available memory cards :

<u>Item number</u>	<u>Memory size (Kbytes)</u>
50W-006	8
50W-007	32

### ***3.7 Pulse input of main meter***

The main meter that should be recorded is normally connected to terminals 11 and 12 of the pulse counter. Special input wiring then ensures the perfect recording of the pulses which come from the generator. Since the wiring of slow-speed and conventional meters with reed contact looks different to that of high-speed electronic systems, there must be a corresponding conversion via software.

The input filter has to make sure that for conventional slow-speed meters up to 1 Hz the input arrangement is adapted to a pulse duty factor of 1:5. By high-speed meters up to 100 Hz, the input arrangement should be adapted to a pulse duty factor of 1:1.

The mark-space ratio describes the relation between switch-on time and switch-off time.

### ***3.8 Further pulse inputs***

A characteristic feature of the IZM 972 are the two further inputs and outputs. These can be used very flexibly. If the pulse counters are supplied as normal standard instruments, two additional inputs are programmed with a pulse valency of 10 l/Imp in each case. Slow-speed meters with reed contact can be connected to these inputs, e.g. a cold and a hot water meter. The consumption and critical date data can be retrieved or queried remotely via the display.

The display of the pulse counter can now be programmed so that the unit shown can be cubic metres (m<sup>3</sup>), litres (l) or also without a unit. The unit-less display is designed for any simple pulse counting of external events.

Each of these inputs can now be programmed be individually as an output also. This means that one can have two inputs (EE) or two outputs (AA), or also one input and one output (EA) available.

### 3.9 Further pulse outputs

The additional pulse outputs allow to transfer the volume or an eventual error of the pulse counter to an other external meter or to an PLC-control system in case the information is required on a different place.

#### 3.9.1 Presentation of outputs

The two inputs or outputs are designated as IO1 and IO2 to improve identification. The maximum frequency at each output is 1 Hz.

The following functions can be realised at output **IO1**:

Output for        volume of the volumetric measuring unit  
                         1 Hz signal (second pulse)

For output **IO2** the following applies:

Output for        volume of the volumetric measuring unit  
                         volume of the meter at IO1  
                         continuous signal if error detected

Pulse rate and unit

The following tables show the relation of the pulse rates of the main volume input, of the energy unit and of the corresponding output pulse rate. The indicated values correspond to the standard configuration of the calculating unit as is normally supplied. But the units and pulse rates can be individually reprogrammed with the software PcRead S1 or Dialog S1.

Pulse rate of the main volume input	Unit main volume	Output pulse rate main volume
1 L / Imp	00000.001 m <sup>3</sup>	1 L
2.5 L / Imp	00000.001 m <sup>3</sup>	10 L
25 L / Imp	000000.01 m <sup>3</sup>	100 L
10 L / Imp	000000.01 m <sup>3</sup>	10 L
100 L / Imp	0000000.1 m <sup>3</sup>	100 L
250 L / Imp	00000001 m <sup>3</sup>	1 m <sup>3</sup>
1000 L / Imp	00000001 m <sup>3</sup>	1 m <sup>3</sup>

### 3.9.2 Timing of the outputs

#### Course of the signal

The outputs always send pulses with an output frequency of 1 Hz and a pulse duty factor of approx. 1:1:

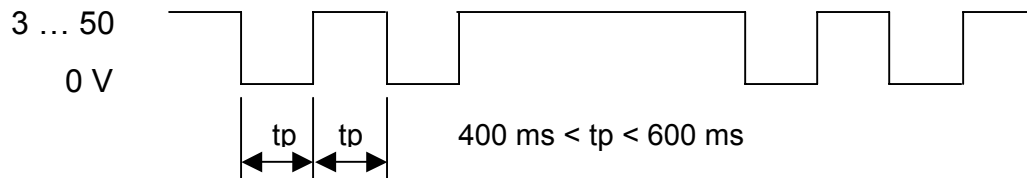

Normally, synchronous to the further switching of the last position in the display, a pulse is also output via the output. In certain cases where the output frequency would exceed the maximum frequency of 1 Hz, the second position must be deviated to. In the case of the energy display, this would look, for example, as follows:

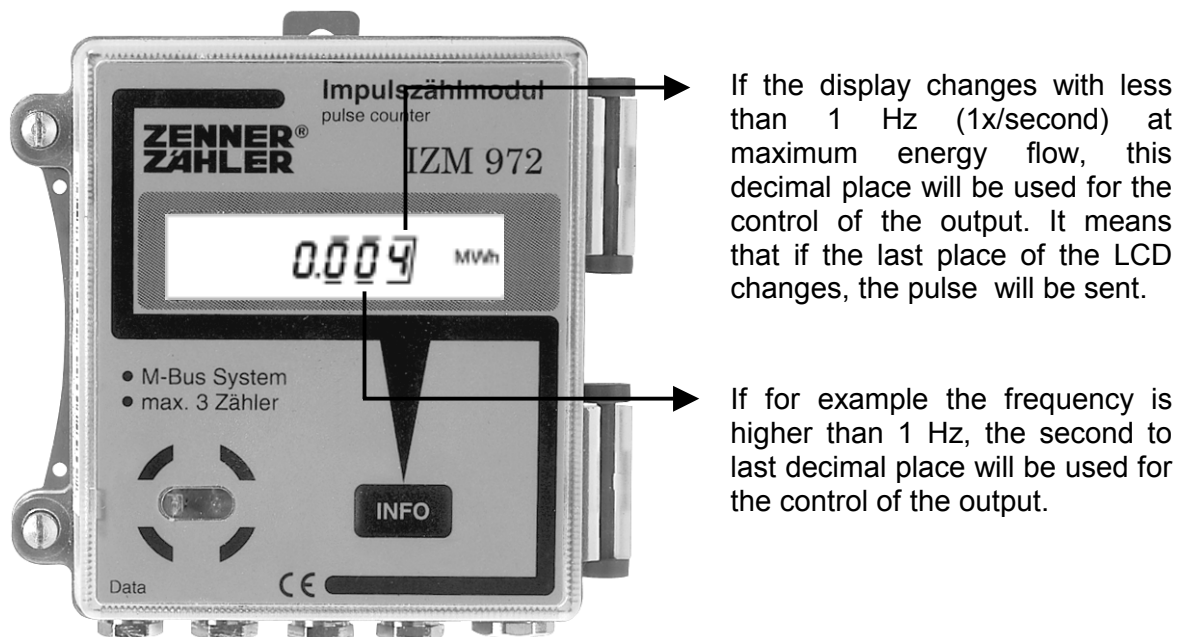

The outputs are fundamentally designed so that both battery-operated meters and PLC controls can be connected.

Battery-operated meters can have inputs with any impedance, since the supply in very high-impedance meters is adopted by the calculating unit itself. C-Mos inputs with a current consumption of less than 3  $\mu$ A can be controlled directly by the energy meter.

PLC inputs are normally designed for a voltage of 24 volt and a current of 10mA. These values are completely fulfilled. It should only be noted that a LOW-switching input of the PLC is required. A user should also be aware that the output of the calculating unit is not saved, as is otherwise common for PLC controls, against all possible errors. In order to determine which valency is output at the output, the configuration menu (level 3) will be used. This menu can only be seen, however, if the port was programmed to output. The display menu for the outputs has the following fundamental structure:

### " X - OC YZ"

**X** stands for the corresponding output channel

X=1 means the values for the IO1 stand here

X=2 means the values for the IO2 stand here

**OC** stands for Open Collector and indicates that the output functions are described here.

**Y** corresponds to the position which is output at this output.

Y=0 or 1, means that the last position is output

Y=2 means that the second-to-last position is output.

**Z** corresponds to the function which is output:

- 1 - energy
- 2 - volume (volumetric measuring unit)
- 3 - additional volume IO1
- 4 - second pulse
- 5 - error signal (continuous level)

Here are a few possibilities of both output wirings:

- 1 - OC 12 last position of the volume is output at IO1
- 1 - OC 22 second-to-last position of the volume is output at IO1.
- 1 - OC 04 1 Hz Signal is output at IO1.
- 2 - OC 12 last position of the volume is output at IO2
- 2 - OC 22 second-to-last position of the volume is output at IO2.
- 2 - OC 13 the last position of the additional volume from IO1 is output at IO2
- 2 - OC 05 IO2 is switched to if there is an error

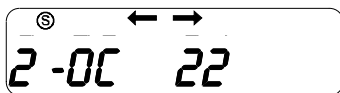

Example display for output (IO2, second-to-last position, volumes)

### 3.9.3 Basic circuit diagram of the outputs

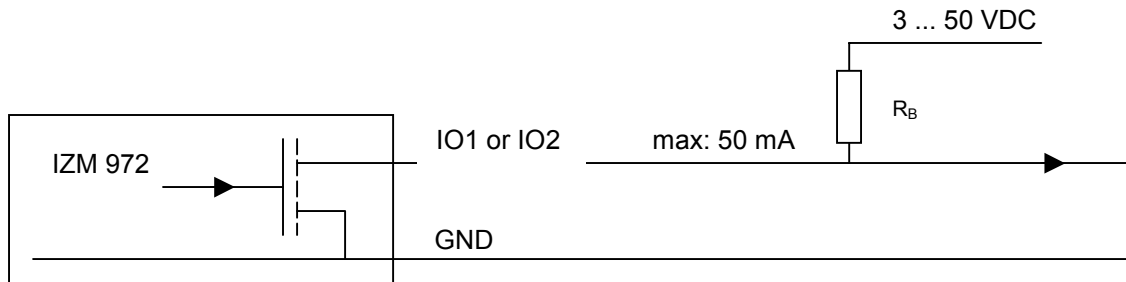

The following tables show the relation of the voltage value and the resistance value based on 10 mA current of the outputs. The resistance is only necessary if the meter on which the output will be connected, has got a passive input (without power supply).

U	R <sub>B</sub> (Ohm)
5 V	500
3 V	300
12 V	1200
24 V	2400

$$I = \frac{U}{R} \quad R = \frac{U}{I} \quad R = \frac{3 \text{ V}}{0,01 \text{ A}}$$

U: power supply

R<sub>B</sub>: resistance to power limitation

### 3.9.4 Galvanic division of the outputs

If we talk about galvanic division of the outputs, very often we relay connection. Relays have a high power consumption which normally can not be provided by a battery-operated pulse counter. But for IZM a relay connection is not necessary. As the complete pulse counter has no conductive connection to its environment, it is galvanically divided from its environment. The pulse counter takes over the potential of the outputs. Notes: Both outputs have to work with the same potential.



### **3.10 Link to the outside world - the interfaces**

4 different interfaces are available:

- the infra-red interface on the left corner of the front.
- the RS232 interface (standard PC-interface)
- the Zenner Bus interface (RS485)
- the Mbus interface (standard Metering Bus of the meter sector)

In principle all interfaces use the same protocol which means that the datas to be read-out are handled according to the same pattern.

Furthermore is valid:

„If the optical interface is active (the INFO key on the pulse counter has been pressed), no data transmission via a bus system is possible for a short time”: if at the same time a read-out occurs via another interface, no data can be received.

### 3.10.1 The infra-red interface

In order to read the meter data quickly and with certainty, or to set individual parameters of the calculating unit on site, each pulse counter is fitted with an optic interface - the infra-red interface. With the aid of an optical reading head (available as an accessory) the meter data can now be read with the widest variety of devices such as a laptop, PC or with our portable reading system, "PSION workabout". The interface is located on the front side of the pulse counter, in the bottom left corner, and can be recognised by the broken circle with the heading "Data". The reading head can be mounted here briefly.

Normally however, the infra-red interface is disconnected for in order to save energy. To quit a data transfer, the INFO key needs to be pressed. The interface is now active. If no signal is detected, the scan is terminated 10 seconds after the key has been pressed.

If a signal is waiting at the time of scanning, the interfaces switches to optic receive. This means that the receiver remains switched on permanently and the microprocessor works at full speed in order to be able to receive and process data from the optic interface. This state remains active for 10 seconds and is extended by a further 10 seconds with each character which is detected free of errors.

The following procedure is necessary when reading:

1. Mount infra-red head in bottom left corner; cable must lead away downwards
2. Switch on reading device and prepare for reading
3. Press INFO key at energy meter
4. Start read command at reading device within 10 seconds

After transfer is completed, the interface becomes inactive after 5 seconds

### 3.10.2 RS232 interface

For pure point to point connections, i.e. only one pulse counter is linked to one reading device, an RS232 variant is also available (Option BR).

With this option a few terminals are additionally placed on the left half of the connection board. The appendix contains a detailed connection diagram.

An individual information sheet can be requested for handling the communication protocol.

A point-to-point link is also possible with a standard device. The optical reading head and the M-bus protocol can be used for this. Handling the telegrams which are necessary for this is described in the information sheet "Mbus-protocol with point-to-point link".

### 3.10.3 ZR-bus interface

One disadvantage with MBus systems is that feeding devices or repeaters must always be used, even if only a few devices are to be networked. These feeding devices are relatively expensive. Smaller networks are therefore hardly worthwhile. To remedy this, the ZR-bus was developed. This is an RS 485 bus. The meters are simply networked with each other and guided at the end to a connection socket. From this, the network can be completely read by means of a reading device.

### 3.10.4 The MBus interface

As an option, the pulse counter is also available with a fitted MBus interface (Option BM). If the calculating unit is connected to the bus, it is possible to supply power continuously via the bus. The battery is disconnected at that moment from the meter and only becomes active again if the bus fails. Since it is now no longer necessary to check the capacity of the battery, the measuring cycle is therefore reduced to 10 seconds.

The same applies for calculating the flow rate which in this way can work with an error rate of less than 1%.

In the case of MBus devices, two more terminals are mounted on the connection board. The row of terminals is extended to the left by two bright blue terminals for connecting the bus.

The optical interface is not operated when in MBus state. Data can only be transferred via the connected bus. However, this interface is always in receive mode, and it is not necessary to press a key before transferring data. Further details about the bus can be found in a separate brochure.

### ***3.11 Power supply with battery***

Two types of battery are basically available for supplying the energy meter. For standard devices, type AA lithium batteries are used. The capacity of the battery is sufficient for a service life of at least 6 years.

In the case of MBus devices, a lithium thionyl chloride battery with a higher rated voltage is usually used, namely 3.6 V and approximately 2.3 Ah.

After an operating period of 6 years, the battery must be replaced on all accounts, as otherwise the pulse counter ceases to work. After 6 years, a "battery empty" symbol appears in the top left-hand corner of the display to announce that the battery must be replaced (see display menus). In addition, the end of the rated service life of the battery can be read in the configuration menu (data "battery empty").

### ***3.12 External power supply***

Each pulse counter which features an Bus oder an RS232 option can be supplied with a standard mains unit.

### 3.13 Diagnosis of the inputs

This display reflects the current state of the most important inputs. It is resident in the test menu (level 4). Each position of the display can only show a "0" or a "1" and is assigned to one input exactly in accordance with the following table. This allows the functions of the pulse generator such as the volumetric measuring unit and additional meters to be tested. The other testing possibilities are of interest to skilled technicians only. The display is to be interpreted as follows:

1xxxxxxx 0xxxxxxx	reed switch at the input of the main meter closed reed switch at the input of the main meter open
x1xxxxxx x0xxxxxx	reed switch at additional input IO1 closed reed switch at additional input IO1 open
xx1xxxxx xx0xxxxx	reed switch at additional input IO2 closed reed switch at additional input IO2 open
xxx1xxxx xxx0xxxx	test mode active test mode inactive
xxxx1xxx xxxx0xxx	external supply active (battery disconnected) device works with battery
xxxxx1xx xxxxx0xx	programming block closed programming block open
xxxxxx1x xxxxxx0x	break level at serial data input rest level at serial data input
xxxxxxx1 xxxxxxx0	main meter can process max. 100 Hz (fast VMT) main meter can work with max.1 Hz(Reed or sim.)

## 4. Connection possibilities

Individual terminals are provided on the connection board for connecting meters. To test the pulse counter and to connect the additional memory, which must not always be accessible, there are additional plug-type connections on the circuit board.

Furthermore there is room on the connection board for another battery (type ½ AA), with which, for instance, electronic meters or volumetric measuring units can be supplied.

### Connection terminals :

10	green	main pulse input
11	dark grey	" (0 Volt)
9	orange	battery voltage (only when additional battery in use)
16	green	input/output IO1
18	green	input/output IO2
17	dark grey	shared ground for terminal 21 and 22

### Additional connections for M-Bus devices:

24	blue	MBus
25	blue	"

### Additional connections for ZR-Bus devices:

71	orange	+Ub
72	dark grey	GND
73	blue	B
74	blue	A

### Additional connections for RS-232 devices:

71	orange	DTR
72	dark grey	GND
73	white	TxD
74	white	RxD

**Connection board standard and RS-232**

**Standard**

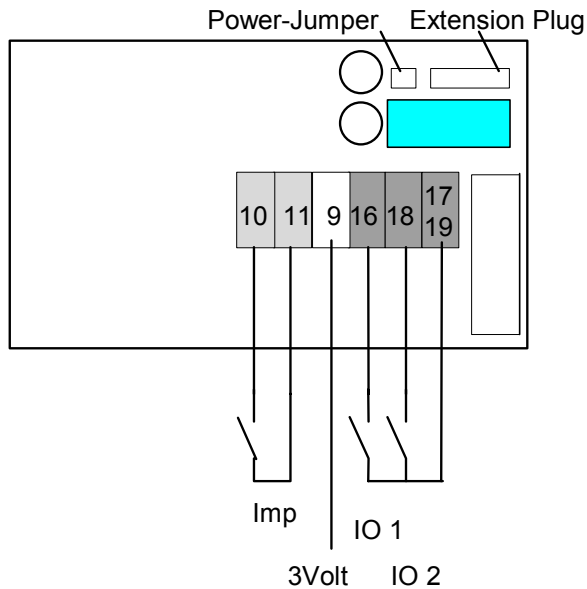

**Legende:**

- Imp:** Main pulse input
- IO1:** Puls input/output 1
- IO2:** Puls input/output 2

**Power-Jumper**

- Mains connection or battery
- Jumper connected= external supply
- Jumper disconnected= battery operated

**Extension plug**

- For extension with a data logger or for testing of the pulse counter

**RS232**

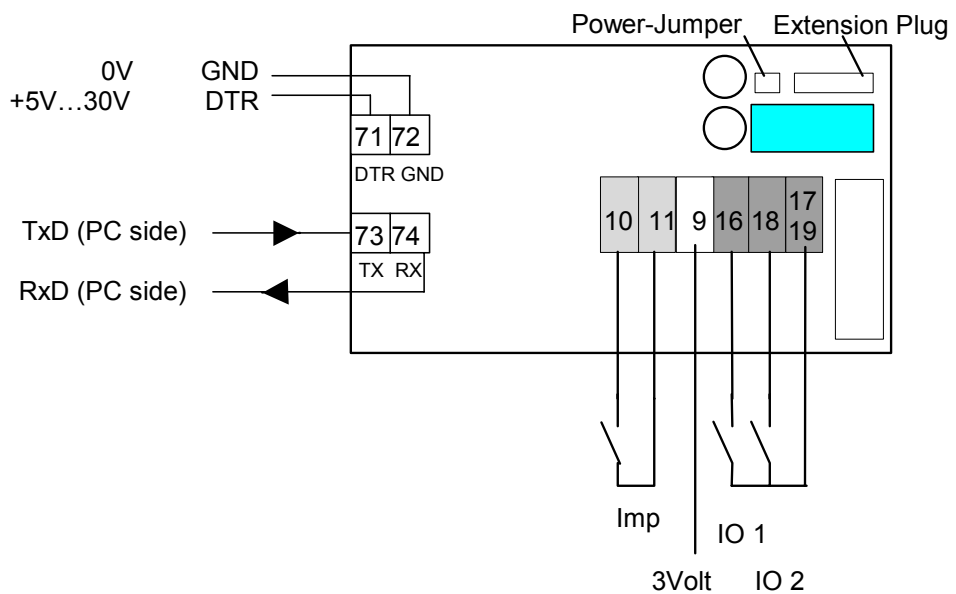

## Connection board ZR Bus and M-Bus

### ZR Bus

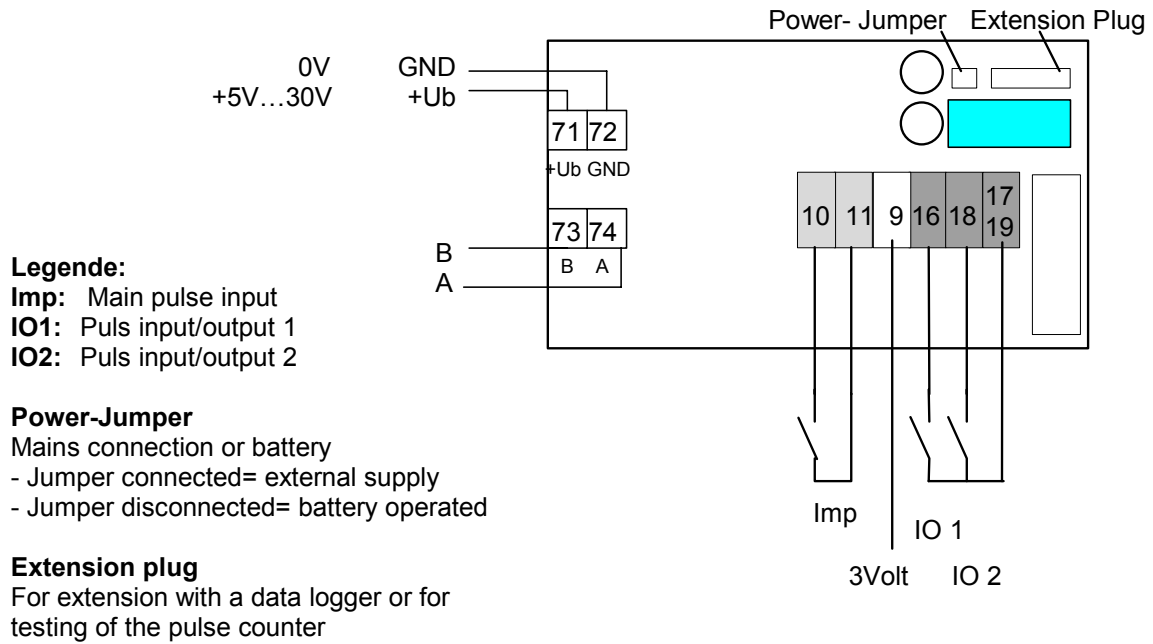

### M-Bus

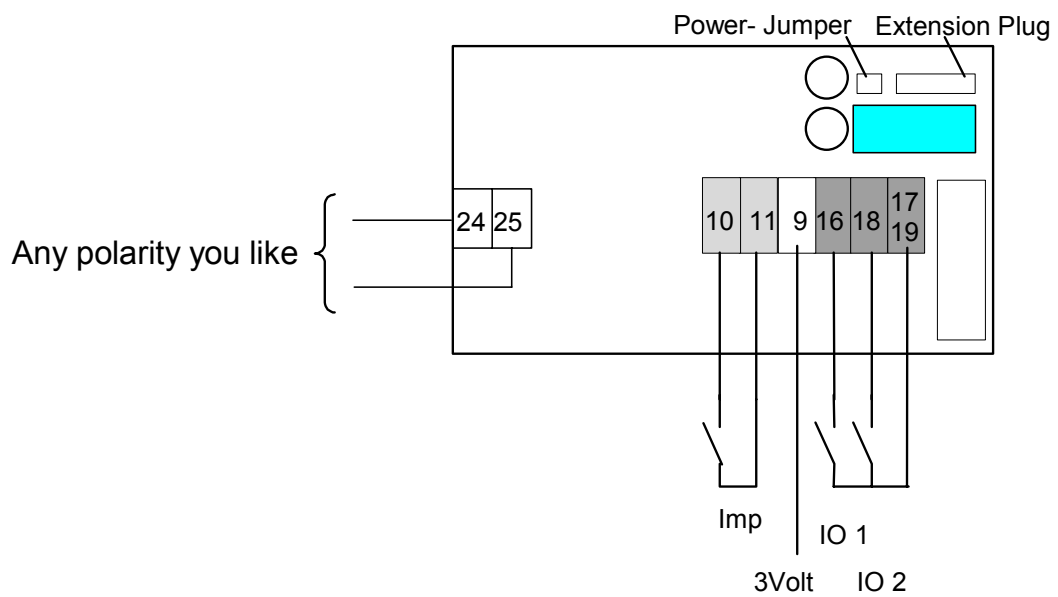



## 5. Dimensions and dimensional diagrams

